



Replaces Toro Groundsmaster 4010-D

Parts

Rotary Mower - Model 30607

Right-Hand & Left-Hand Deck Hydraulics and Discharge Chambers

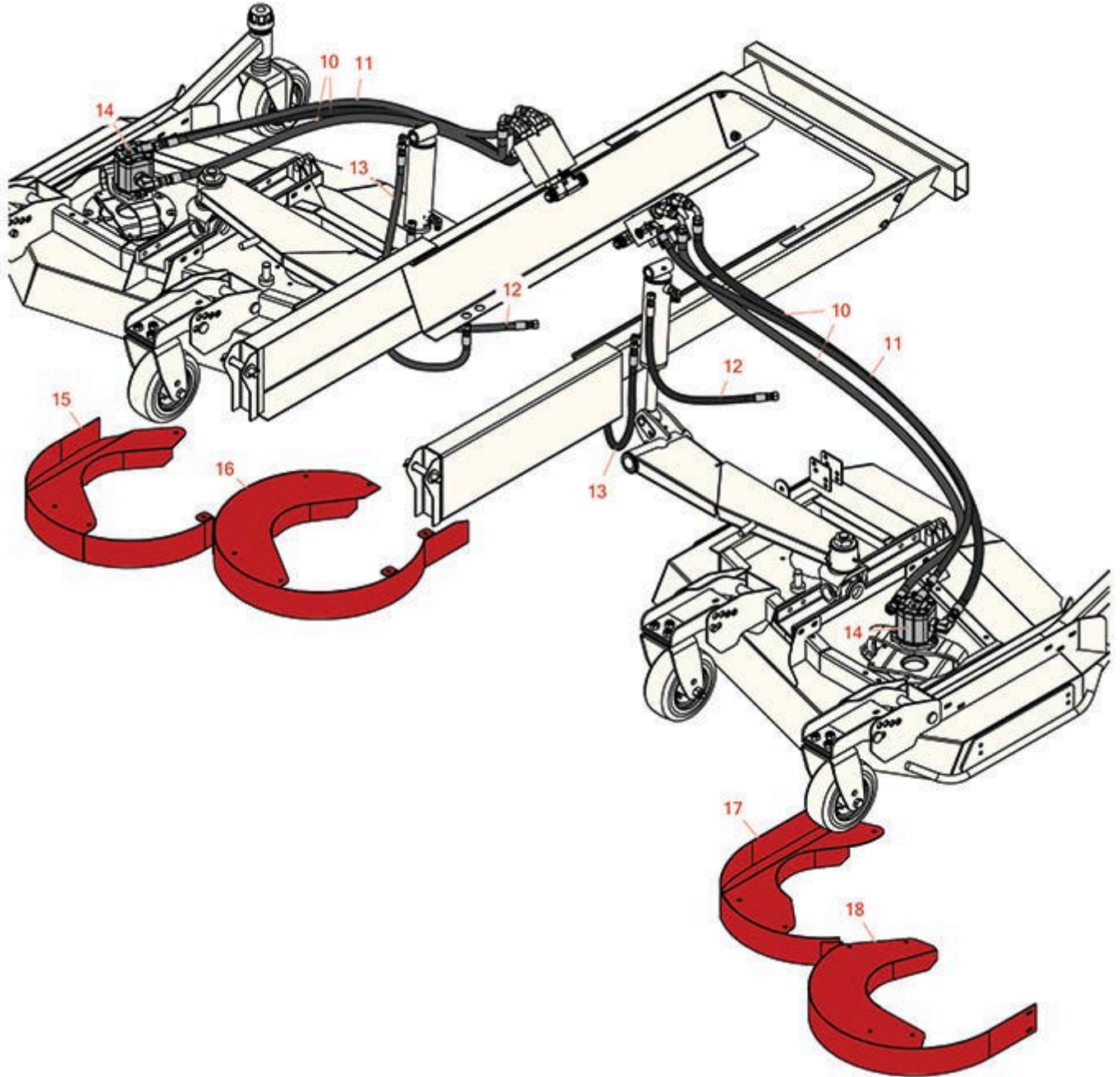

All original equipment manufacturers names and part numbers are used for identification purposes only, and we are in no way implying that our products are original equipment parts. Prices subject to change without notice.



Replaces Toro Groundsmaster 4010-D Parts

Rotary Mower - Model 30607

Right-Hand & Left-Hand Deck Hydraulics and Discharge
Chambers



Item No	R&R Part No.	OEM Part No.	Description	Qty Req	Order Quantity
10	R104-2263	104-2263	Hydraulic Hose Assy	4	
<i>Tech Note: 30410/30412/30448:</i>					
10	R120-8959	120-8959	Hydraulic Hose Assy	4	
<i>Tech Note: 30605/30609:</i>					
11	R104-2265	104-2265	Hydraulic Hose Assy	2	
12	R100-5629	100-5629	Hydraulic Hose Assy	2	
<i>Tech Note: 30410/30412/30448:</i>					
13	R100-5630	100-5630	Hydraulic Hose Assy	2	
<i>Tech Note: 30410/30412/30448:</i>					
14	R99-5489	99-5489	Hydraulic Motor	2	
<i>Tech Note: 30410/30412/30448/30605_2013/ 30609_2013:</i>					
15	R104-2203-01	104-2203-01	Outer Chamber Assy	1	
<i>Tech Note: 30410/30412/30448_2010-2011yr:</i>					
16	R104-2204-01	104-2204-01	Inner Chamber Assy	1	
<i>Tech Note: 30410/30412/30448/30605_2013-2015/30609_2013-2015:</i>					
17	R104-2205-01	104-2205-01	Inner Chamber Assy	1	
<i>Tech Note: 30410/30412/30448/30605_2013-2015/30609_2013-2015:</i>					
18	R120-4132-01	120-4132-01	Outer Chamber Assy	1	
<i>Tech Note: 30448_2012-2014/30608_2013-2015/30609_2013-2015:</i>					
18	R104-2206-01	104-2206-01	Outer Chamber Assy	1	
<i>Tech Note: 30410/30412/30448:</i>					

All original equipment manufacturers names and part numbers are used for identification purposes only, and we are in no way implying that our products are original equipment parts. Prices subject to change without notice.



Replaces Toro Groundsmaster 4010-D Parts

Rotary Mower - Model 30607

*Right-Hand & Left-Hand Deck Hydraulics and Discharge
Chambers*



All original equipment manufacturers names and part numbers are used for identification purposes only, and we are in no way implying that our products are original equipment parts. Prices subject to change without notice.