

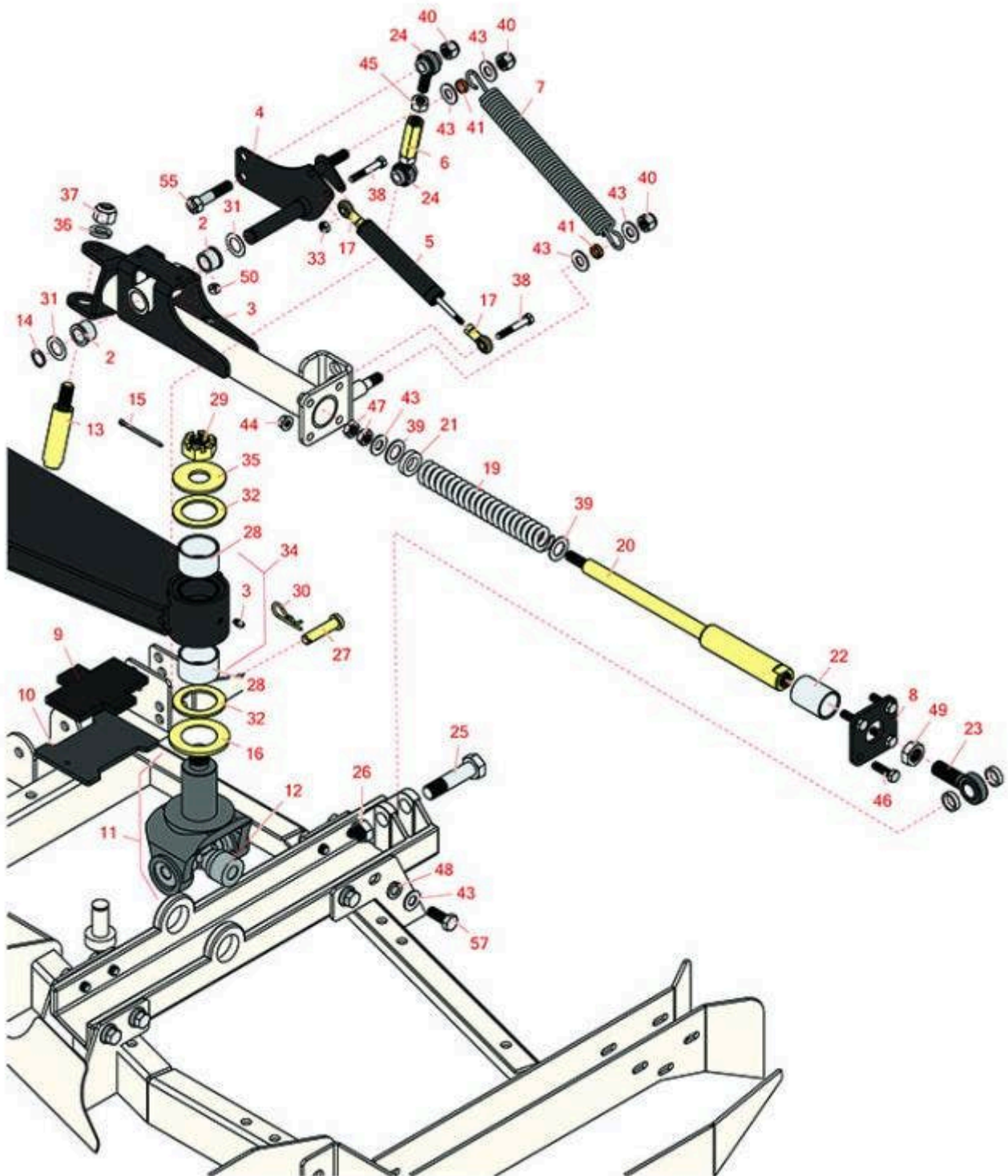

Replaces Toro Groundsmaster 4010-D Parts

Rotary Mower - Model 30603
Side Deck Lift Arm and Damper



All original equipment manufacturers names and part numbers are used for identification purposes only, and we are in no way implying that our products are original equipment parts. Prices subject to change without notice.



Replaces Toro Groundsmaster 4010-D Parts

Rotary Mower - Model 30603
Side Deck Lift Arm and Damper



Item No	R&R Part No.	OEM Part No.	Description	Qty Req	Order Quantity
2	R256-113	256-113	Bushing - 3/4 ID x 1 1/8 Flange	4	
3	R302-5	21-6010, 302-11, 302-37, 302-47, 302-5, 302-57, 302-58, 302-6, 31-0300, 32-9660, 60-0800, 62-3880, 92-4181	Fitting - Grease	2	
4	R108-1476-03	100-5690-03, 108-1476-03, 114-2717	LH Bell Crank Assy	1	
4	R108-1475-03	100-5684-03, 108-1475-03, 114-2716	RH Bell Crank Assy	1	
5	R105-3249	104-7512, 105-3249	Damper	2	
6	R105-2809	105-2809	Tube - Link	2	
7	R104-7520	104-7520	Spring - Damper	2	
8	R105-2807-03	105-2807-03	Plate	2	
9	R104-8348	104-8348	Plate-Rubber	2	
10	R108-1528-03	108-1528-03	Plate	2	
11	R114-5640-03	114-5640-03	Yoke - Joint Assy w/Bearing	2	
12	R104-4299	104-4299	Cross and Bearing	2	
13	R104-2281	104-2281	Shaft- Pivot	2	

All original equipment manufacturers names and part numbers are used for identification purposes only, and we are in no way implying that our products are original equipment parts. Prices subject to change without notice.



Replaces Toro Groundsmaster 4010-D Parts

*Rotary Mower - Model 30603
Side Deck Lift Arm and Damper*



Item No	R&R Part No.	OEM Part No.	Description	Qty Req	Order Quantity
14	R32120-93	32120-93	Snap Ring - HD	2	
15	R3272-25	01-151-0020, 3272-25	Pin-Cotter	2	
16	R104-0720	104-0720	Spacer	2	
17	R104-8331	104-8331	Rod End - Spherical	4	
19	R100-8138	100-8138	Spring-Compression	2	
20	R105-4548	105-4548	Shaft - Spring	2	
21	R105-4552	105-4552	Bearing - Plastic	2	
22	R105-4550	105-4550	Bushing - Straight	2	
23	R105-2806	105-2806	Rod End	2	
24	R105-2808	105-2808	Rod End	4	
25	R328-5	01-150-0690, 01-178-1228, 328-5	Bolt - Hx HD 3/4-10 x 3 1/2	2	
26	R3296-51	3296-51, 3296-81	Nut - Nylon Lock 3/4-10 Gr 8	2	
27	R92-2739	92-2739	Pin - Clevis	2	
28	R104-8341	104-8341	Bushing - 1 1/4 in Straight	4	
28	R114-5596	114-5596	Bushing - 1 in Straight	4	
29	R99-3139	11-5800, 99-3139, Nov-00	Nut	2	
30	R3290-467	3290-467	Pin-Hair	2	
31	R3-6498	3--6498, 3-6498, 47-8270	Washer - Thrust	4	

All original equipment manufacturers names and part numbers are used for identification purposes only, and we are in no way implying that our products are original equipment parts. Prices subject to change without notice.



Replaces Toro Groundsmaster 4010-D Parts

*Rotary Mower - Model 30603
Side Deck Lift Arm and Damper*



Item No	R&R Part No.	OEM Part No.	Description	Qty Req	Order Quantity
32	R104-0721	104-0721	Washer - Thrust	4	
33	R3296-29	1-804256, 3290-357, 3296-29, 915662P	Locknut - 5/16-18 ESNA	6	
34	R119-0089	119-0089	LH Lift Arm Assy	1	
34	R119-0087	119-0087	RH Lift Arm Assy	1	
35	R104-0719	104-0719	Washer - Hardened	2	
36	RF104	01-166-0020, 01-166-1010, 23-15-GD, 30-8480, 3253-8, 48-9400	Washer - Lock 5/8	2	
37	R3296-53	3296-53	Locknut - 5/8-11 ESNA Yellow	2	
38	R322-10	20-30-AD, 24-7180, 322-10, 322-10 , 3223-6, 513347	Bolt - Hex HD 5/16-18 x 2	4	
39	R105-4551	105-4551	Washer- Flat	4	
40	RF5003	32127-29, 32131-5, 32132-5, 3296-23	Locknut - ESNA 1/2-13	6	
41	R104-7521	104-7521	Bushing	4	

All original equipment manufacturers names and part numbers are used for identification purposes only, and we are in no way implying that our products are original equipment parts. Prices subject to change without notice.



Replaces Toro Groundsmaster 4010-D Parts

Rotary Mower - Model 30603
Side Deck Lift Arm and Damper



Item No	R&R Part No.	OEM Part No.	Description	Qty Req	Order Quantity
43	R3256-26	01-166-0540, 01-166-0820, 17-2530, 24-13-BD, 30-8570, 3256-26, 356206, 48-9390	Washer - 1/2 in	26	
44	R3296-39	32127-25, 32128-36, 3290-357, 3296-17, 3296-22, 3296-39, 915663P, 99-7443	Locknut - 3/8-16 Nylon	8	
45	RMM607	01-158-0610, 01-191-0820, 21-3900, 3220-5, 45-0170, 5/1/3220	Nut - Jam 1/2-20 Zinc	2	
46	R400264	01-150-0180, 01-178-0610, 20-48-AD, 20-48-AGD, 32-9160, 3224-3, 323-29, 323-7, 400264, 908035P	Bolt - Hex HD 3/8-16 x 1-1/4	8	
47	R443118	01-188-0813, 22-15-AJD, 3217-9	Nut - 1/2-13 Zinc	4	
48	R3253-7	01-166-0030, 01-166-0080, 01-166-0290, 01-166-0810, 23-13-GD, 3253-7, 48-9380	Washer - Lock 1/2	8	

All original equipment manufacturers names and part numbers are used for identification purposes only, and we are in no way implying that our products are original equipment parts. Prices subject to change without notice.



Replaces Toro Groundsmaster 4010-D Parts

*Rotary Mower - Model 30603
Side Deck Lift Arm and Damper*



Item No	R&R Part No.	OEM Part No.	Description	Qty Req	Order Quantity
49	R3220-7	01-191-1216, 3220-7, Mar-03	Nut - 3/4-16 Jam Zinc	2	
50	R301504	2296-42, 301504, 32127-24, 32128-33, 32146-17, 3296-16, 3296-42, 3296-42 , 915661P	Locknut - ESNA 1/4-20	6	
55	R325-9	01-150-0920, 01-178-0818, 18-9540, 3226-5	Bolt - 1/2-13 x 2 1/4 Hex Head	2	
57	R325-5	01-150-0250, 01-178-0810, 19-8000, 20-86-AGD, 3226-1, 325-5, 513375	Bolt - Hex HD 1/2-13 x 1-1/4	8	

All original equipment manufacturers names and part numbers are used for identification purposes only, and we are in no way implying that our products are original equipment parts. Prices subject to change without notice.