

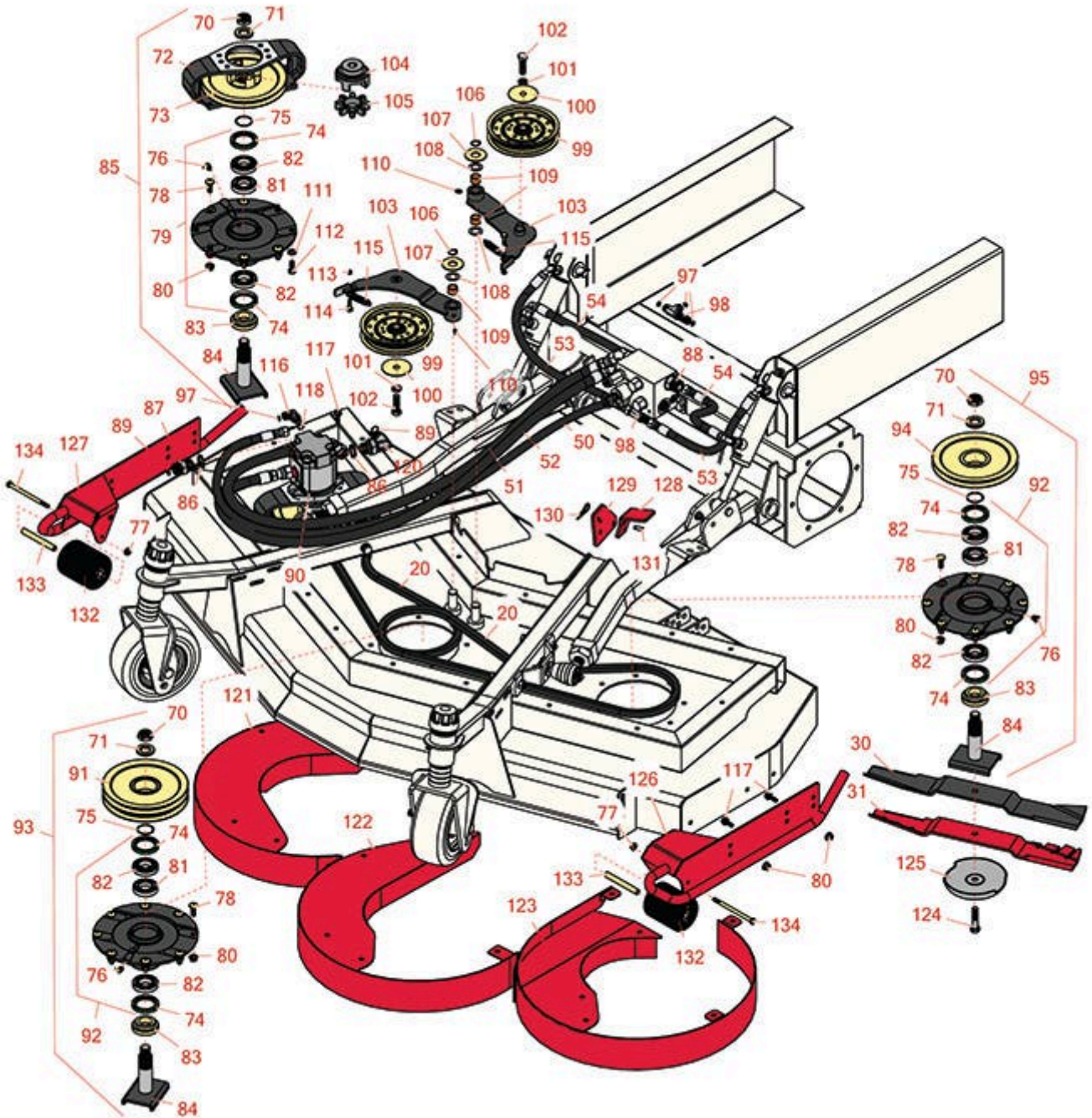

Replaces Toro Groundsmaster 4010-D Parts

Rotary Mower - Model 30603
Front Deck Hydraulics and Spindles



All original equipment manufacturers names and part numbers are used for identification purposes only, and we are in no way implying that our products are original equipment parts. Prices subject to change without notice.



Replaces Toro Groundsmaster 4010-D Parts

Rotary Mower - Model 30603
Front Deck Hydraulics and Spindles



Item No	R&R Part No.	OEM Part No.	Description	Qty Req	Order Quantity
Belts					
20	R55-7660	108-8076	Belt - V Rotary Deck	2	
Rotary Blades Available					
30	R92-5608	92-5608, 92-5608-03	Mower Blade - 21.75 in	3	
31	R92-5608M	104-1303, 107-0214-03	Mower Blade - Mulcher 21.75	3	
Hoses					
50	R112-9126	112-9126	Hydraulic Hose Assy - w/Protective Sleeve	1	
<i>Tech Note: 30410/30412/30448:</i>					
50	R120-8989	120-8989	Hydraulic Hose Assy	1	
<i>Tech Note: 30605/30609:</i>					
51	R104-2260	104-2260	Hydraulic Hose Assy	1	
<i>Tech Note: 30603/30607/30635/30605:</i>					
51	R120-8988	120-8988	Hydraulic Hose Assy	1	
<i>Tech Note: 30605/30609:</i>					
52	R104-2261	104-2261	Hydraulic Hose Assy	1	
<i>Tech Note: 30603/30607/30635/30605:</i>					
52	R120-8987	120-8987	Hydraulic Hose Assy	1	
<i>Tech Note: 30605/30609:</i>					
53	R92-7595	92-7595	Hydraulic Hose Assy	2	
<i>Tech Note: 30410/30412/30448:</i>					
54	R104-2234	104-2234	Hydraulic Hose Assy	2	

All original equipment manufacturers names and part numbers are used for identification purposes only, and we are in no way implying that our products are original equipment parts. Prices subject to change without notice.



Replaces Toro Groundsmaster 4010-D Parts

Rotary Mower - Model 30603
Front Deck Hydraulics and Spindles



Item No	R&R Part No.	OEM Part No.	Description	Qty Req	Order Quantity
Other Parts Available					
70	R32127-46	32127-46, 3296-60	Locknut	3	
71	R104-8322	104-8322, 120-5576	Washer - Spindle Shaft Hardened	3	
72	R104-3544	104-3544	Mount - Motor Drive	1	
73	R104-3545	104-3545	Pulley - Drive	1	
74	R253-154	253-154	Seal - Spindle	6	
75	R106-7159	106-7159	O-Ring	3	
76	R302-60	302-60	Zerk - Grease 90 Deg.	3	
77	R104-8300	104-8300, 104-8300 , 119-4041	Locknut - 5/16-18 Flanged Y/Zinc	2	
78	R114-8195	114-8195, R & R ONLY	Bolt- Ribbed Neck	20	
79	R119-4546	104-3552, 119-3552, 119-4546	Spindle Housing Assy	1	
80	R104-8301	104-8301, 104-9301, 109-6658, 133-7570	Locknut - 3/8-16 Nylon Flanged	20	
81	R104-3549	104-3549	Spacer Set - Spindle Bearing	6	
82	R110-8297	110-8297, 26-1830	Bearing Set w/Retaining Rings - Spindle	3	
83	R92-9800	69-6950, 69-6980, 92-9800	Spacer - Spindle	3	
84	R104-3554	104-3554	Shaft - Spindle Assy.	3	

All original equipment manufacturers names and part numbers are used for identification purposes only, and we are in no way implying that our products are original equipment parts. Prices subject to change without notice.



Replaces Toro Groundsmaster 4010-D Parts

Rotary Mower - Model 30603
Front Deck Hydraulics and Spindles



Item No	R&R Part No.	OEM Part No.	Description	Qty Req	Order Quantity
85	R119-4547	104-3529, 119-4547, 139-1035	Driving Spindle Assy	1	
86	R237-81	237-81, 237.81, 327-81	O-Ring	2	
<i>Tech Note: 30410/30412/30448:</i>					
87	R340-8	340-8	Adapter	1	
<i>Tech Note: 30410/30412/30448:</i>					
88	R340-9	340-9	Fitting - Straight Connector	2	
<i>Tech Note: 30605/30609:</i>					
89	R237-65	237-65, 237.65	O-Ring	2	
<i>Tech Note: 30410/30412/30448:</i>					
90	R127-3694	127-3694	Hydraulic Motor	3	
<i>Tech Note: 314000001-314999999 and Newer:</i>					
90	R99-5489	99-5489	Hydraulic Motor	3	
<i>Tech Note: 313000001-313999999:</i>					
91	R104-3547	104-3547	Pulley - Double Driven	1	
92	R119-4775	119-4775	Spindle Housing Assy	2	
93	R119-4548	104-3530, 119-4548, 139-1037	Double Driven Spindle Assy	1	
94	R104-3548	104-3548	Pulley - Higher Driven	1	
95	R119-4549	104-3531, 119-4549, 139-1038	High Driven Spindle Assy	1	

All original equipment manufacturers names and part numbers are used for identification purposes only, and we are in no way implying that our products are original equipment parts. Prices subject to change without notice.



Replaces Toro Groundsmaster 4010-D Parts

Rotary Mower - Model 30603
Front Deck Hydraulics and Spindles



Item No	R&R Part No.	OEM Part No.	Description	Qty Req	Order Quantity
97	R237-22	107-8844, 237-22, 237-78	O-Ring	7	
<i>Tech Note: 30410/30412/30448:</i>					
98	R340-68	340-120, 340-68	Fitting - Tee - Bulkhead	2	
<i>Tech Note: 30410/30412/30448:</i>					
99	R110-9596	110-9596, 132-9421	Pulley- Flat Idler	2	
100	R100-3102	100-3102	Washer-Flat	2	
101	R3253-7	01-166-0030, 01-166-0080, 01-166-0290, 01-166-0810, 23-13-GD, 3253-7, 48-9380	Washer - Lock 1/2	2	
102	R325-7	01-150-0380, 01-178-0814, 3226-3, 325-7, 48-9490	Bolt - 1/2-13 x 1 3/4 Hex HD Gr 5	2	
103	R110-6128	110-6128	Idler Arm Assy	2	
104	R104-3541	104-3541	Hub - Drive	1	
105	R104-3542	104-3542	Spider	1	
106	R458013	30-0580, 32120-72, 458013, 93-2525, 936125	Ring - Retaining	2	
107	R70-1160	70-1160	Washer	2	

All original equipment manufacturers names and part numbers are used for identification purposes only, and we are in no way implying that our products are original equipment parts. Prices subject to change without notice.



Replaces Toro Groundsmaster 4010-D Parts



*Rotary Mower - Model 30603
Front Deck Hydraulics and Spindles*

Item No	R&R Part No.	OEM Part No.	Description	Qty Req	Order Quantity
108	R3-6498	3--6498, 3-6498, 47-8270	Washer - Thrust	4	
109	R256-76	256-76	Bushing	4	
110	R302-5	21-6010, 302-11, 302-37, 302-47, 302-5, 302-57, 302-58, 302-6, 31-0300, 32-9660, 60-0800, 62-3880, 92-4181	Fitting - Grease	2	
111	R453011	01-166-0100, 01-166-0120, 01-166-0270, 01-166-0500, 01-166-0600, 01-166-0620, 132-4593, 2356-3, 237-12, 24-10-AD, 24-11-AD, 24-11-BD, 24-12-AD, 24-12-BD, 30-9310, 32-8190, 3256-24, 3256-3, 3256-36, 3256-4, 453011, 47-9950, 48-9220, 513458, 7-0052	Washer - Flat 3/8 SAE Y/Zinc	4	

All original equipment manufacturers names and part numbers are used for identification purposes only, and we are in no way implying that our products are original equipment parts. Prices subject to change without notice.



Replaces Toro Groundsmaster 4010-D Parts

Rotary Mower - Model 30603
Front Deck Hydraulics and Spindles



Item No	R&R Part No.	OEM Part No.	Description	Qty Req	Order Quantity
112	R323-6	01-150-0010, 01-178-0608, 20-47-AD, 20-47-AGD, 3224-2, 323-6, 49-3510, 908034P, 908332	Bolt - Hex HD 3/8-16 x 1 GR5 YZ	4	
113	R3296-56	3296-56	Nut - Lock - 1/4-20 ESNA Jam	2	
114	R104-0858	104-0858	Bolt - Shoulder	2	
115	R107938	107938	Spring - Extension	2	
116	R340-77	340-100, 340-77, 95-7889	Hydraulic Fitting	1	
117	R3234-42	3234-42	Bolt - 3/8-16 x 1 Hx HD Fl	2	
118	R237-42	237-42, 31-4160	O-Ring	1	
120	R340-139	340-139	Hydraulic Fitting - 90 Deg	1	
<i>Tech Note: 30410/30412/30448:</i>					
121	R104-2201-01	104-2201-01	Chamber Assy - RH	1	
122	R104-2200-01	104-2200-01	Chamber Assy - Center	1	
123	R104-2202-01	104-2202-01	Chamber Assy - LH	1	
124	R92-5816	92-5816	Bolt - Hex HD 1/2-20 x 2-1/4	3	
125	R72-9361	27-1000, 27-1001, 72-9360, 72-9361	Cup - Anti-Scalp	3	
126	R100-5612-01	100-5612-01	Skid Assy - LH	1	

All original equipment manufacturers names and part numbers are used for identification purposes only, and we are in no way implying that our products are original equipment parts. Prices subject to change without notice.



Replaces Toro Groundsmaster 4010-D Parts

*Rotary Mower - Model 30603
Front Deck Hydraulics and Spindles*



Item No	R&R Part No.	OEM Part No.	Description	Qty Req	Order Quantity
127	R100-5605-01	100-5605-01	Skid Assy - RH	1	
128	R106-2032-01	106-2032-01	Latch - Deck	1	
129	R106-2033-01	106-2033-01	Plate - Latch	1	
130	R3290-467	3290-467	Pin-Hair	1	
131	R283-62	283-62	Pin - Clevis 5/16 x 3/4	1	
132	R93-4803	93-4803	Roller - Deck	2	
133	R105-4549	105-4549	Spacer - Deck Roller	2	
134	R322-29	322-29	Bolt - Hex HD 5/16-18 x 5 GR5	2	

All original equipment manufacturers names and part numbers are used for identification purposes only, and we are in no way implying that our products are original equipment parts. Prices subject to change without notice.