

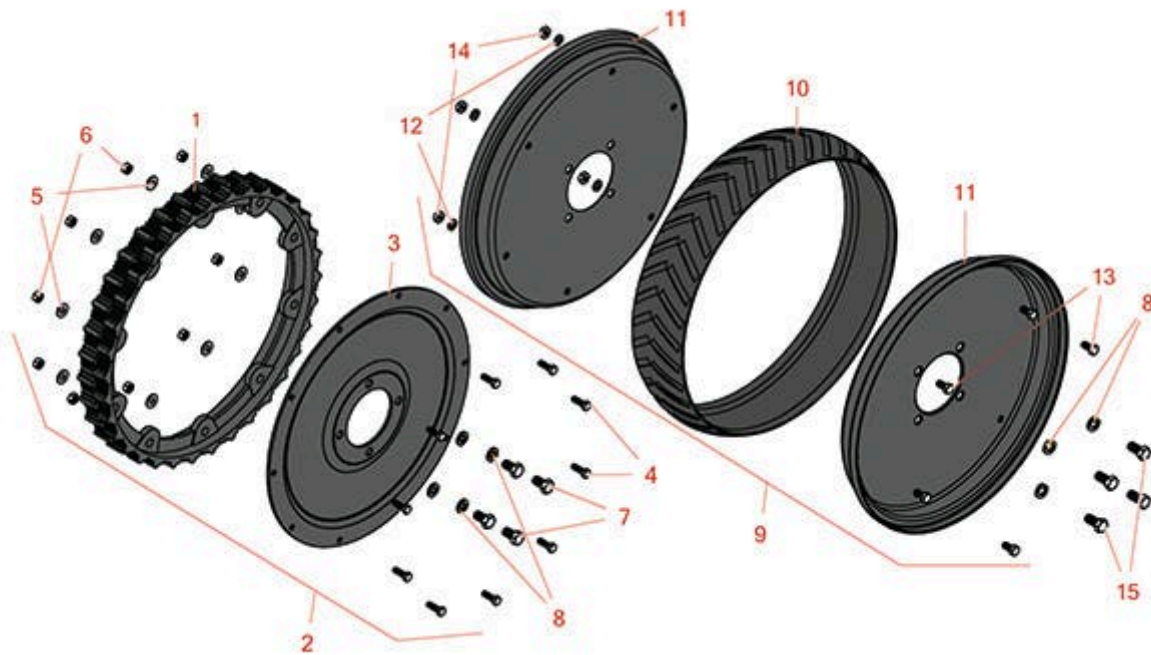

Replaces R&R Products Power Lift

5133GD Parts

Standard Cutting Unit
Tires & Wheels



All original equipment manufacturers names and part numbers are used for identification purposes only, and we are in no way implying that our products are original equipment parts. Prices subject to change without notice.



Replaces R&R Products Power Lift 5133GD Parts

Standard Cutting Unit
Tires & Wheels



Item No	R&R Part No.	OEM Part No.	Description	Qty Req	Order Quantity
Steel Wheels					
1	R203987B	R012620	Wheel - 18 Rim 18 OD	2	
1	R203992B	R009203	Wheel - 17 Rim 17 OD	2	
2	R101425B		Wheel - 18 w/ Disc Assy (2 Ea)	1	
2	R101426B		Wheel - 17 w/ Rim Assy (2 Ea)	1	
3	R315938B	R006445	Disc - 18 Wheel	2	
3	R315939		Disc - 17 Wheel	2	
4	R400226		Bolt - Hex HD 5/16-24 x 1	20	
5	R310266	3256-3, R09056, R452004	Washer - Flat 5/16 USS	20	
6	R444754	R000210	Locknut - 5/16-24 Center	20	
7	R400436		Bolt - Hex HD 1/2-20 x 7/8	8	
8	R446154	R446152	Washer - Lock 1/2	16	
Semi-Pneumatic Wheels					
9	R70094B		Wheel Assy - 4x17 (2 Ea) 17 OD	1	
9	R70097B	R009213	Wheel Assy - 4x20 (2 Ea) 20OD	1	
10	R316482		Tire - 4x20 Semi Pneumatic 20 in OD	2	
10	R344137		Tire - 4x17 Semi Pneumatic 17 in OD	2	
11	R329120B	R020158	Disc - Half 4x17 - 14O.D.	4	
11	R336054B	R009212	Disc - Half 4x20 - 17 O.D.	4	

All original equipment manufacturers names and part numbers are used for identification purposes only, and we are in no way implying that our products are original equipment parts. Prices subject to change without notice.



Replaces R&R Products Power Lift 5133GD Parts

*Standard Cutting Unit
Tires & Wheels*



Item No	R&R Part No.	OEM Part No.	Description	Qty Req	Order Quantity
12	R3254-6	446142, R01-166-0010, R01-166-0280, R01-166-0610, R12H304, R3253-5, R3254-18, R3290-223, R446140, R446142, R48-9370	Washer - Lock 3/8	12	
13	R400258	R01-150-0800, R01-178-0600, R01-178-0606, R20-45-AD, R31-0200, R31-9910, R3224-1, R323-4	Bolt - Hex HD 3/8-16 x 3/4	12	
14	R443110		Nut - 3/8-16 Hex	12	
15	R400438	R3213-1	Bolt - Hex HD 1/2-20 x 1	8	

All original equipment manufacturers names and part numbers are used for identification purposes only, and we are in no way implying that our products are original equipment parts. Prices subject to change without notice.