

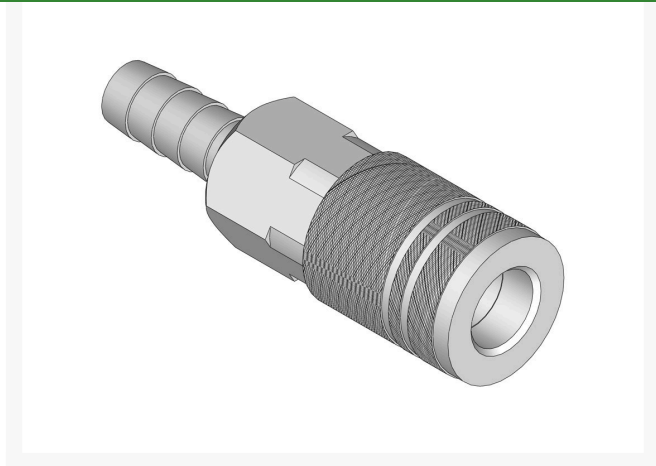

Coupler - 3/8 Hose Barb R5533



Details

Plated steel couplers with hardened steel balls & stainless steel springs or brass fittings that offer corrosion resistance, ductility at high temperatures, and low magnetic permeability. Maximum working pressure 300 PSI.

Specifications

Manufacturer

R&R Products

Krima Trading AB

Stene 710 Kumla, 692 93

+46 19 57 35 20

<https://krima.rrproducts.com/>